



FOUNTAINS
FONTANE
FUENTES
FONTAINES





ASOLA

BELLITALIA DESIGN



CURVED
PLATE



LINEAR
PLATE



ANGULAR
PLATE

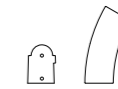

CURVED
ASHLAR



RIGHT
ANGLE
ASHLAR



LEFT
ANGLE
ASHLAR



LINEAR
ASHLAR

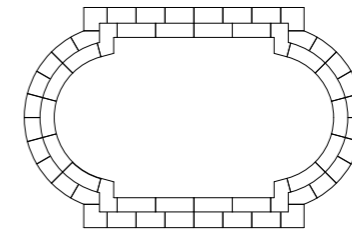

L 8840 mm
W 5740 mm
H 500 mm
11283 kg

MATERIALS / MATERIALI / MATERIALES / MATÉRIAUX:

NATURAL MARBLE STONES
PIETRE DI MARMMO NATURALI
PIEDRAS DE MÁRMOL NATURAL
PIERRES DE MARBRE NATURELLES

WHITE GRANITE
GRANITO BIANCO
GRANITO BLANCO
GRANIT BLANC



FINISHING / FINITURE / ACABADOS / FINITIONS:



ACCESSORIES / ACCESSORI / ACCESORIOS / ACCESSOIRES:





CALLA

BELLITALIA DESIGN

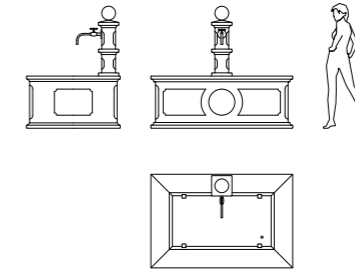

L 1847 mm
W 1220 mm
H 1591 mm
2000 kg

MATERIALS / MATERIALI / MATERIALES / MATÉRIAUX:

NATURAL MARBLE STONES
PIETRE DI MARMO NATURALI
PIEDRAS DE MÁRMOL NATURAL
PIERRES DE MARBRE NATURELLES

WHITE GRANITE
GRANITO BIANCO
GRANITO BLANCO
GRANIT BLANC

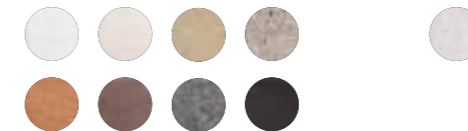

FINISHING / FINITURE / ACABADOS / FINITIONS:



ACCESSORIES / ACCESSORI / ACCESORIOS / ACCESSOIRES:



GIRASOLE

BELLITALIA DESIGN





GIRASOLE

BELLITALIA DESIGN



CURVED
PLATE

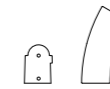

CURVED
ASHLAR

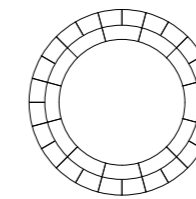

Ø 4840 mm
H 500 mm
5568 kg

MATERIALS / MATERIALI / MATERIALES / MATÉRIAUX:

NATURAL MARBLE STONES
PIETRE DI MARMO NATURALI
PIEDRAS DE MÁRMOL NATURAL
PIERRES DE MARBRE NATURELLES

WHITE GRANITE
GRANITO BIANCO
GRANITO BLANCO
GRANIT BLANC

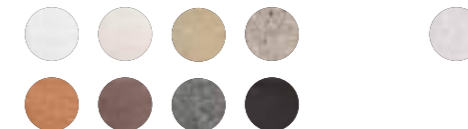

FINISHING / FINITURE / ACABADOS / FINITIONS:



ACCESSORIES / ACCESSORI / ACCESORIOS / ACCESSOIRES:





MARGHERITA

BELLITALIA DESIGN

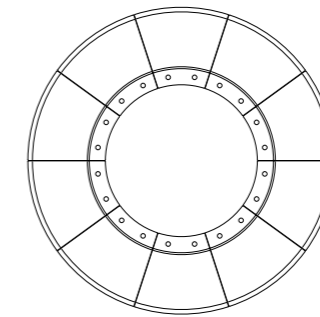
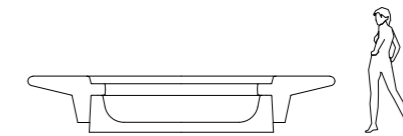

Ø 4000 mm
H 502 mm
8337 kg

MATERIALS / MATERIALI / MATERIALES / MATÉRIAUX:

NATURAL MARBLE STONES	WHITE GRANITE
PIETRE DI MARMO NATURALI	GRANITO BIANCO
PIEDRAS DE MÁRMOL NATURAL	GRANITO BLANCO
PIERRES DE MARBRE NATURELLES	GRANIT BLANC

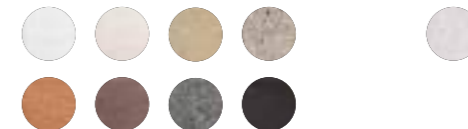

FINISHING / FINITURE / ACABADOS / FINITIONS:

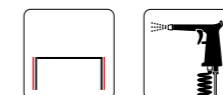
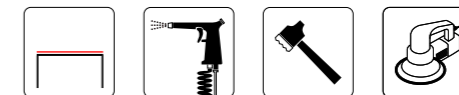

ACCESSORIES / ACCESSORI / ACCESORIOS / ACCESSOIRES:

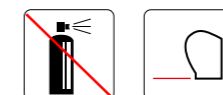

ORCHIDEA

BELLITALIA DESIGN





ORCHIDEA

BELLITALIA DESIGN



CURVED
PLATE

ANGULAR
PLATE

CURVED
ASHLAR

POINTED
ASHLAR

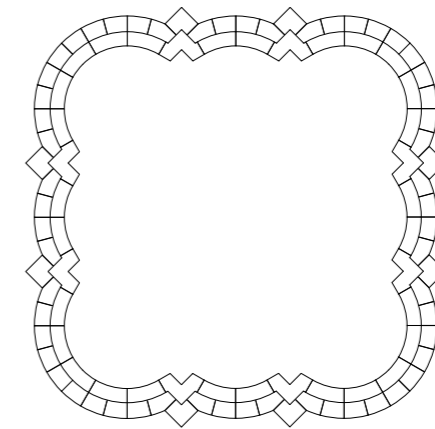

L 12840 mm
W 12840 mm
H 500 mm
18060 kg

MATERIALS / MATERIALI / MATERIALES / MATÉRIAUX:

NATURAL MARBLE STONES
PIETRE DI MARMO NATURALI
PIEDRAS DE MÁRMOL NATURAL
PIERRES DE MARBRE NATURELLES

WHITE GRANITE
GRANITO BIANCO
GRANITO BLANCO
GRANIT BLANC

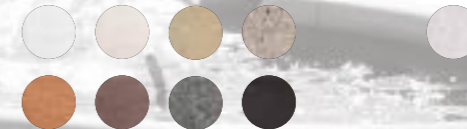

FINISHING / FINITURE / ACABADOS / FINITIONS:



ACCESSORIES / ACCESSORI / ACCESORIOS / ACCESSOIRES:





QUADRIFOGLIO

BELLITALIA DESIGN



CURVED
PLATE



ANGULAR
PLATE



CURVED
ASHLAR



POINTED
ASHLAR

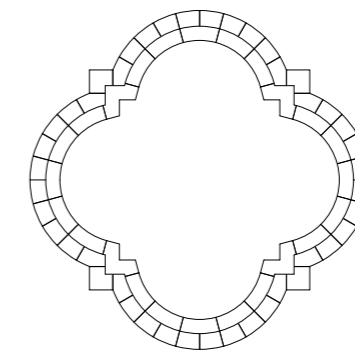

L 8840 mm
W 8800 mm
H 500 mm
11576 kg

MATERIALS / MATERIALI / MATERIALES / MATÉRIAUX:

NATURAL MARBLE STONES
PIETRE DI MARMO NATURALI
PIEDRAS DE MÁRMOL NATURAL
PIERRES DE MARBRE NATURELLES

WHITE GRANITE
GRANITO BIANCO
GRANITO BLANCO
GRANIT BLANC

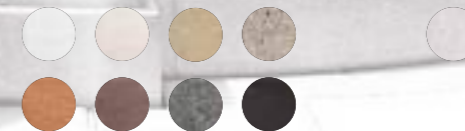

FINISHING / FINITURE / ACABADOS / FINITIONS:

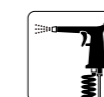

ACCESSORIES / ACCESSORI / ACCESORIOS / ACCESSOIRES:



SORAGA

BELLITALIA DESIGN





SORAGA

BELLITALIA DESIGN

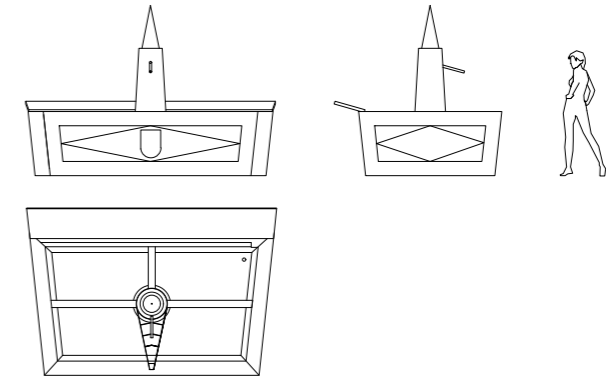

L 3498 mm
W 3225 mm
H 2345 mm
2386 kg

MATERIALS / MATERIALI / MATERIALES / MATÉRIAUX:

NATURAL MARBLE STONES
PIETRE DI MARMO NATURALI
PIEDRAS DE MÁRMOL NATURAL
PIERRES DE MARBRE NATURELLES

WHITE GRANITE
GRANITO BIANCO
GRANITO BLANCO
GRANIT BLANC

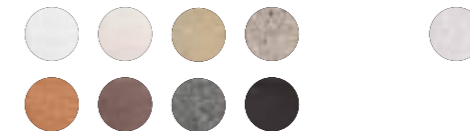

FINISHING / FINITURE / ACABADOS / FINITIONS:



ACCESSORIES / ACCESSORI / ACCESORIOS / ACCESSOIRES:

